

EARTH CLAMP

METRACLIP EARTH











ENGLISH

Operating Instructions

 GOSSEN METRAWATT

Thank you for purchasing a **METRACLIP EARTH earth clamp**. For best results from your instrument:

- **read** these operating instructions carefully,
- **comply with** the precautions for use.

| Symbol | Meaning |
|--|---|
|  | WARNING, risk of DANGER! The operator must refer to these instructions whenever this danger symbol appears. |
|  | Equipment protected throughout by double or reinforced insulation. |
|  | Application or withdrawal authorized on uninsulated or bare conductors at dangerous voltages. |
|  | The product has been declared recyclable after analysis of its life cycle in accordance with the ISO 14040 standard. |
|  | An Eco-Design approach has been adopted in order to design this appliance. Analysis of the complete lifecycle has enabled us to control and optimize the effects of the product on the environment. In particular this appliance exceeds regulation requirements with respect to recycling and reuse. |
|  | The CE marking indicates conformity with European directives, in particular LVD and EMC. |
|  | The rubbish bin with a line through it indicates that, in the European Union, the product must undergo selective disposal in compliance with Directive WEEE 2012/19/EU. This equipment must not be treated as household waste |
|  | Useful information or tip. |

Definition of measurement categories:

- Measurement category IV corresponds to measurements taken at the source of low-voltage installations.
Example: power feeders, counters and protection devices.
- Measurement category III corresponds to measurements on building installations.
Example: distribution panel, circuit-breakers, machines or fixed industrial devices.
- Measurement category II corresponds to measurements taken on circuits directly connected to low-voltage installations.
Example: power supply to domestic electrical appliances and portable tools.

PRECAUTIONS FOR USE

This instrument and its accessories comply with safety standards EN 61010-1, EN 61010-030, and EN 61010-2-032 for voltages of 600V in category IV at an altitude of less than 2000 m, indoors, with a degree of pollution of not more than 2.

Failure to observe the safety instructions may result in electric shock, fire, explosion, and destruction of the instrument and of the installations.

- The operator and/or the responsible authority must carefully read and clearly understand the various precautions to be taken in use. Sound knowledge and a keen awareness of electrical hazards are essential when using this instrument.
- If you use this instrument other than as specified, the protection it provides may be compromised, thereby endangering you.
- Do not use the instrument on networks of which the voltage or category exceeds those mentioned.
- Do not use the instrument if it seems to be damaged, incomplete, or poorly closed.
- Before each use, check the condition of the insulation on housing. Any item of which the insulation is deteriorated (even partially) must be set aside for repair or scrapping.
- Use personal protection equipment systematically.
- When handling the instrument, keep your fingers behind the physical guard.
- All troubleshooting and metrological checks must be performed by competent and accredited personnel.
- Avoid impacts on the measurement head, in particular the air gap.
- Keep the surfaces of the air gap clean; even a little dirt can cause the clamp to malfunction.

Note: Bluetooth[®] is a registered trade mark.

CONTENTS

| | <i>Page</i> |
|--|-------------|
| | 1 |
| DEFINITION OF MEASUREMENT CATEGORIES: | 2 |
| CONTENTS | 4 |
| 1. GETTING STARTED | 7 |
| 1.1 Scope of supply | 7 |
| 1.2 INSERTING THE BATTERIES | 7 |
| 1.3 Setting the date and time | 7 |
| 1.4 EXAMPLE OF DISPLAY | 8 |
| 2. DESCRIPTION OF THE DEVICE | 8 |
| 2.1 FUNCTIONS OF THE DEVICE | 9 |
| 2.2 FRONT PANEL | 10 |
| 2.3 DEVICE-REAR PANEL | 12 |
| 2.4 DISPLAY UNIT | 13 |
| 2.5 AUDIBLE SIGNALS..... | 15 |
| 3. MEASUREMENT PRINCIPLE | 16 |
| 4. USE..... | 17 |
| 4.1 INSERTING THE BATTERIES | 17 |
| 4.2 COMMISSIONING THE DEVICE | 17 |
| 4.3 SETTING THE INTERNAL CLOCK..... | 17 |
| 4.4 STANDARD OR ADVANCED MODE..... | 18 |
| 4.5 USE OF THE FUNCTIONS | 18 |
| 4.6 USE OF THE <i>Hold</i> KEY | 18 |
| 4.7 USE OF <i>Pre-Hold</i> | 19 |
| 4.8 STORAGE OF THE DATA | 19 |
| 4.8.1 Conditions..... | 19 |
| 4.8.2 EFFECTIVE STORAGE..... | 19 |
| 4.8.3 INFORMATION CONCERNING THE STORED DATA | 19 |
| 4.8.4 MEMORY FULL | 19 |
| 4.8.5 READING THE STORED DATA | 20 |
| 4.9 MANAGEMENT OF THE ALARMS | 20 |
| 4.9.1 NO ALARM DETECTION..... | 20 |
| 4.9.2 VOLTAGE ALARM..... | 20 |
| 4.9.3 CURRENT ALARM | 21 |
| 4.9.4 IMPEDANCE ALARM | 21 |
| 5. Ω +A POSITION..... | 23 |
| 5.1 USE IN <i>Standard</i> MODE | 23 |
| 5.1.1 OBJECT..... | 23 |

| | | |
|-------|--|----|
| 5.1.2 | PARAMETERIZING THE MEASUREMENT | 23 |
| 5.1.3 | MEASUREMENT | 23 |
| 5.1.4 | MEASUREMENT RESULT | 24 |
| 5.1.5 | STORAGE OF THE MEASUREMENTS | 24 |
| 5.1.6 | PRESENCE OF ALARMS | 24 |
| 5.2 | USE IN <i>ADVANCED</i> MODE | 24 |
| 5.2.1 | OBJECT | 24 |
| 5.2.2 | SELECTION | 24 |
| 5.2.3 | PARAMETERIZING THE MEASUREMENT | 24 |
| 5.2.4 | MEASUREMENT | 25 |
| 5.2.5 | MEASUREMENT RESULT | 25 |
| 5.3 | COMPLEMENTARY INFORMATION | 26 |
| 5.3.1 | PRODUCT ZXI GREATER THAN 50V | 26 |
| 5.3.2 | IMPEDANCE GREATER THAN 1500Ω | 27 |
| 5.3.3 | PERTURBING LEAKAGE CURRENT | 27 |
| 5.3.4 | CURRENT GREATER THAN 10A | 27 |
| 5.3.5 | STORAGE OF THE MEASUREMENTS | 28 |
| 5.3.6 | PRESENCE OF ALARMS | 28 |
| 6. | POSITION A | 29 |
| 6.1 | OBJECT | 29 |
| 6.2 | PARAMETERIZING THE MEASUREMENT | 29 |
| 6.3 | MEASUREMENT | 29 |
| 6.4 | MEASUREMENT RESULT | 29 |
| 6.5 | PRESENCE OF ALARMS | 29 |
| 6.6 | MANAGEMENT OF THE ALARMS | 30 |
| 7. | MEMORY READ (MR) | 31 |
| 7.1 | OBJECT | 31 |
| 7.2 | SELECTION OF THE <i>memory read</i> MODE | 31 |
| 7.3 | DATA DISPLAYED | 31 |
| 7.3.1 | DATA DISPLAYED IN <i>Standard</i> MODE | 31 |
| 7.3.2 | DATA DISPLAYED IN <i>ADVANCED</i> MODE | 32 |
| 7.3.3 | USE OF THE KEYS | 33 |
| 7.3.4 | ERASURE OF THE STORED DATA | 33 |
| 7.3.5 | EXITING FROM THE READ MODE | 34 |
| 8. | SET-UP | 35 |
| 8.1 | OBJECT | 35 |
| 8.2 | ACCESS TO THE <i>SET-UP</i> MENUS | 35 |
| 8.3 | DISPLAY OF THE <i>SET-UP</i> MENUS | 35 |
| 8.4 | SELECTING A SPECIFIC MENU | 36 |
| 8.5 | DETAILS OF THE <i>SET-UP</i> MENUS | 36 |
| 9. | OFF POSITION | 42 |
| 9.1 | MANUAL SWITCHING OFF | 42 |
| 9.2 | AUTOMATIC SWITCHING OFF | 42 |
| 9.3 | BACKUP OF THE CONFIGURATION | 42 |

| | |
|---|----|
| 9.4 PROLONGED STOP | 42 |
| 10. TECHNICAL CHARACTERISTICS | 43 |
| 10.1 REFERENCE CONDITIONS | 43 |
| 10.2 ELECTRICAL CHARACTERISTICS | 43 |
| 10.2.1 LOOP RESISTANCE MEASUREMENT | 43 |
| 10.2.2 LOOP INDUCTANCE MEASUREMENT | 44 |
| 10.2.3 ESTIMATE OF THE CONTACT VOLTAGE | 44 |
| 10.2.4 CURRENT MEASUREMENT | 44 |
| 10.3 VARIATIONS IN THE DOMAIN OF USE | 45 |
| 10.4 POWER SUPPLY | 45 |
| THE BATTERIES WILL BE WITHDRAWN FOR LONG-TERM STORAGE | 45 |
| 10.5 ENVIRONMENTAL CONDITIONS | 46 |
| 10.6 MECHANICAL CHARACTERISTICS | 46 |
| 10.7 COMPLIANCE WITH INTERNATIONAL STANDARDS | 46 |
| 10.8 Electromagnetic compatibility | 46 |
| THE DEVICE IS COMPLIANT WITH STANDARD IEC-61326-1 | 46 |
| 11. SERVICING AND MAINTENANCE | 47 |
| 11.1 Cleaning | 47 |
| 11.2 Replacement of the batteries | 47 |
| 11.2.1 PROCEDURE | 47 |
| 11.2.2 PRESERVATION OF STORED DATA | 48 |
| 11.3 CHECK OF ACCURACY | 48 |
| 11.3.1 OBJECT AND EQUIPMENT NECESSARY | 48 |
| 11.3.2 EQUIPMENT | 48 |
| 11.3.3 PROCEDURE | 48 |
| 11.4 ADJUSTMENT | 48 |
| 11.4.1 OBJECT AND EQUIPMENT NECESSARY | 48 |
| 11.4.2 EQUIPMENT | 48 |
| 11.4.3 PROCEDURE | 49 |
| 11.5 Metrological check, Repair and Replacement Parts Service, Calibration Center | 49 |
| 11.6 Product support | 49 |
| 12. WARRANTY | 50 |
| 13. TO ORDER | 51 |

1. GETTING STARTED

1.1 SCOPE OF SUPPLY

| <i>Rep.</i> | <i>Designation</i> |
|-------------|---|
| 1 | Carrying case. |
| 2 | METRACLIP EARTH earth clamp. |
| 3 | Set of 4 AA batteries (1.5 V). |
| 4 | CD containing the operating instructions. |
| 5 | Verification certificate. |
| 6 | Safety data sheet (20 languages) |
| 7 | Quick Start guide |

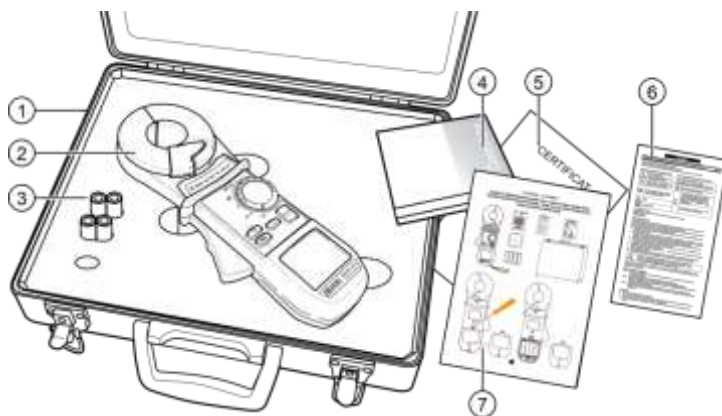

Fig. 1

1.2 INSERTING THE BATTERIES

Refer to §11.2.

1.3 SETTING THE DATE AND TIME

Set the function switch to **Ω+A**. All icons of the display unit light for approximately 2 seconds. The device waits for the date and time of the device to be set using the **▲**, **▼**, and **▶** keys; refer to § 4.3 for a detailed description of the procedure.

1.4 EXAMPLE OF DISPLAY

The figure opposite shows a display, upon first use, with the device set to $\Omega+A$. The measured current is 30.0 mA and the impedance is 7.9 Ω .

The buzzer is active and the memory is empty.

Note: This display corresponds to the Standard mode. In the Advanced mode, 2 additional screens are available; see §5.2.

The figure opposite shows a display, upon first use, with the device set to **A**. The current measured is 30.0 mA.

The buzzer is active and the memory is empty.



Fig. 2

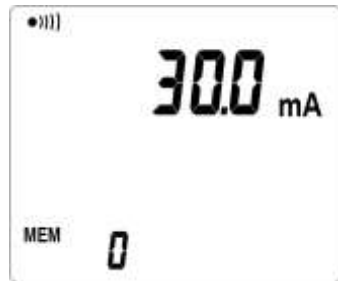

Fig. 3

2. DESCRIPTION OF THE DEVICE

The earth clamp is intended for testing the resistances of any conducting system having the characteristics of a conducting loop. It is used to perform:

- Earth resistance measurements if the earth is in series in a loop with its continuity conductor;
- Other earth measurements: earth extended, for example by means of a guard wire between power transmission or telecommunication poles;
- Or the distributed earths of a single earth plane.

2.1 FUNCTIONS OF THE DEVICE

- Easy-to-use device intended for measurement of the loop impedance in a parallel earth network, by a simpler method than the traditional method with 2 auxiliary rods.

Loop ohmmeter: measurement of loop impedances from 0.01 Ω to 1,500 Ω .
The ohmmeter function makes allowance for the presence of inductances in the loop, making impedance measurements more accurate at low values.

Ammeter: current measurements from 0.2 mA to 40 A.

Contact voltage: the contact voltage is estimated by calculating the product of the loop impedance by the leakage current. The value found is an upper bound on the voltage between the measurement point and earth, since the impedance taken into account is that of the whole loop.

- Large multi-function OLED display unit.
- Display in Standard mode (only 1 screen) or Advanced mode (3 screens).
- Clamping diameter 35 mm.
- Storage of measurements (Ω and/or A, with time-stamping).
METRACLIP EARTH: up to 2000 measurements stored.
- Possibility of reading out the stored measurements on the clamp itself.
METRACLIP EARTH: Read-out also possible via Bluetooth®
- Measurement hold by the **HOLD** key and/or by opening the clamp (PRE-HOLD mode).
- Weight limited by the use of powerful magnetic materials.
- Opening the clamp made easy by a trigger with a force compensation system.
- Advanced ergonomics (grip and reading of the display unit).
- Small influence of spurious currents.

2.2 FRONT PANEL

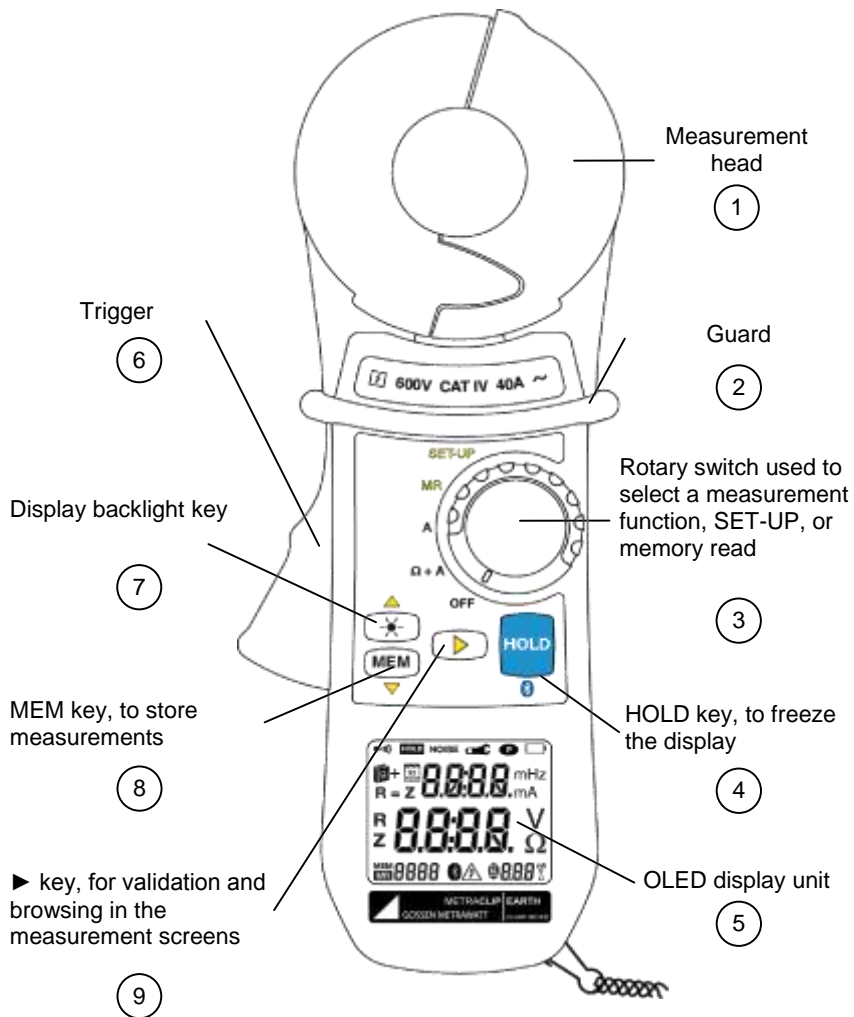

Fig. 4

| Rep. | Designation | See § |
|-------------|---|--------------|
| 1 | Measurement head. | - |
| 2 | Guard. The user's hand must be below this zone and not touch the measurement head (item 1). | - |
| 3 | Function switch. | 4.5 |
| | OFF: device off. | 9 |
| | Ω+A: simultaneous selection of the <i>Loop impedance measurement</i> and the <i>Leakage current measurement</i> . | 5 |
| | A: selection of the <i>Current measurement</i> . | 6 |
| | MR: (<i>Memory Read</i>) display of the data stored when MEM (item 8) was pressed. | 7 |
| | SET-UP: access to configuration of the parameters and to erasure of the stored measurements. | 8 |
| 4 | HOLD key: freezes the measured and displayed values, at any time, along with the various functional indications. | 4.6 |
| | Ⓚ: When the function switch is set to MR or SET-UP , pressing this key activates or deactivates the Bluetooth® connection. | |
| 5 | OLED display unit. | 2.4 |
| 6 | Measurement head opening trigger. | - |
| 7 | Dual-function key: | - |
| | ✱ (when device is set to Ω+A or A): increases the brightness of the OLED display unit; makes it easier to read the display unit in an environment with strong background illumination. Highlighting activated for 30 seconds. | - |
| | ▲ (when device is set to SET-UP or MR): serves as up arrow when browsing in the menus and values. The brightness of the display unit does not change when device is set to SET-UP or MR . | - |
| 8 | Dual-function key. | - |
| | MEM (when device is set to Ω+A or A): records the measured value. All of the data are recorded, in the <i>Standard</i> or <i>Advanced</i> mode. | 4.8 |
| | ▼ (when device is set to SET-UP or MR): serves as down arrow when browsing in the menus and values. | - |

| Rep. | Designation | See § |
|-------------|--|--------------|
| 9 | ▶ Function that depends on the setting of the function switch, as follows: | |
| | <i>When the device is set to Ω+A (Advanced Mode)</i> | 5.2.5 |
| | <i>Short press:</i> switches the display through the following 3 modes, in order: <ul style="list-style-type: none"> ■ Display of the impedance recalculated at the selected frequency. ■ Display of the contact voltage (product Z^*l). ■ Display of R and L. | |
| | <i>Long press:</i> activates or deactivates the audible alarms. | 2.5 |
| | <i>when device is set to SET-UP</i> | - |
| | <i>Validation when browsing in the menus and values.</i> | |
| | <i>when device is set to MR (Advanced Mode)</i> | |
| | <i>Switches the display through the measurement screens and the measurement date/time.</i> | |

2.3 DEVICE-REAR PANEL

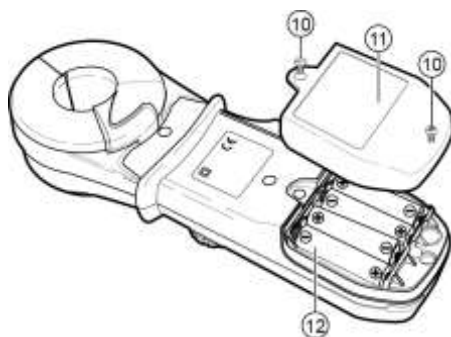

Fig. 5

| Rep. | Designation | See § |
|-------------|---|--------------|
| 10 | Battery compartment cover locking screws. | 11.2 |
| 11 | Battery compartment cover. | 11.2 |
| 12 | Batteries (4 AA – LR6, 1.5 V). | 11.2 |

2.4 DISPLAY UNIT



Fig. 6

| Rep. | Designation | See § |
|-------------|--|--------------|
| 1 | <ul style="list-style-type: none"> ■ Display of the <i>buzzer active</i> state; the icon is masked when the buzzer is inactive. ■ Selection of the buzzer operating mode via <i>SET-UP</i> menu 2. | 8.5 8.5 |
| 2 | Indicator of freezing of the measurement display when the HOLD key is pressed or in the <i>Pre-Hold</i> mode | 4.6 1.1 |
| 3 | Indicates that the main display shows the date (with the function switch set to MR or SET-UP). | 7 |
| 4 | Symbol reporting the presence of perturbations (current) in the loop making it impossible to be sure of the impedance measurement. | - |
| 5 | Upper display unit. 4,000-counts current measurement and 500-counts loop inductance measurement (<i>Advanced</i> mode). | - |
| 6 | Signalling indicating incorrect closing of the clamp; the measurement cannot be made in this case. If the <i>Pre-hold</i> mode is activated, the <i>Hold</i> icon blinks and the measurement is frozen. Selection of the <i>Pre-Hold mode</i> via <i>SET-UP</i> menu 11. | 4.6 8.5 |
| 7 | Permanent operation of the clamp (automatic switching off disabled). Selection of the automatic switching off mode in <i>SET-UP</i> menu 3. | 8.5 |
| 8 | Battery charge indicator with 3 states: <ul style="list-style-type: none"> ■ Not displayed: batteries charged. ■ Blinking: batteries low. The device remains functional, but the batteries will have to be replaced soon. ■ Steady: batteries discharged. The display unit indicates <i>Lo bat</i>. It is impossible to make measurements, read records, or configure parameters. | 11.2.1 |
| 9 | Units of the top measurements display unit: <ul style="list-style-type: none"> ■ mH: loop inductance measurement unit. ■ mA or A: current measurement unit (mA or A). | - |

| | | |
|----|---|-------|
| 10 | Units of the central measurements display unit: | - |
| | <ul style="list-style-type: none"> ■ V: contact voltage measurement unit. ■ Ω: impedance measurement unit. Symbol used for impedances at the measurement frequency, for impedances referred to the network frequency, or for the resistive component. | |
| 11 | Unit of the alarm displayed. The alarm can be defined on an impedance, a voltage, or a current, depending on the measurement chosen (Ω+A or A). | 8.5 |
| | <ul style="list-style-type: none"> ■ A: current measurement alarm. ■ Ω: resistance measurement alarm. ■ V: voltage measurement alarm. | |
| 12 | Alarm threshold display unit: | 8.5 |
| | <ul style="list-style-type: none"> ■ Display of one of the alarms (1000-counts display unit) with the various units. ■ These 3 digits are also used when configuring the time display mode (A. for A.M., P. for P.M. or 24H) in <i>SET-UP</i> menu 8. | |
| 13 | Alarm threshold over(under-)shoot indicator (operational use or parameterizing): | 8.5 |
| | <ul style="list-style-type: none"> ▲ Alarm threshold overshoot indicator. AL <i>Alarm threshold adjustment</i> mode or <i>Alarm</i> function. ▼ Alarm threshold undershoot indicator. | |
| 14 | Signal indicating potentially hazardous voltage. Blinks when the contact voltage exceeds 50V. | - |
| 15 | METRACLIP EARTH: Remains displayed while the <i>Bluetooth</i> connection is being established. Blinks for the duration of the communication. | - |
| 16 | Memory index display unit. 4-digit digital display (0 to 9999 counts): | - |
| | <ul style="list-style-type: none"> ■ Of the measurement sequence number, of the current memory in normal operation associated with the <i>Read (MR)</i> or <i>Storage (MEM)</i> indications. ■ Of the date stamp (year) when the device is parameterized. | |
| 17 | <i>Memory read</i> mode. | 7 |
| 18 | <i>Data storage</i> mode. | 4.8 |
| 19 | In the <i>Advanced</i> mode, these symbols identify the value displayed (resistance or impedance). | 5.2 |
| 20 | Main display unit: | - |
| | <ul style="list-style-type: none"> ■ Measurement of the impedance or voltage. ■ Display of the date and time (month-day and hour-minute) in parameterizing and stored values read mode. | |
| 21 | In <i>Advanced</i> mode, indication displayed when the inductive component is negligible with respect to the resistive component. | 5.2.5 |
| 22 | Indicates selection of the <i>Advanced</i> mode. | 5.2 |

Remark: when switched on, the device performs a rapid self-test of the entire display unit. All available segments are displayed briefly. During this stage, a sustained press on **HOLD** prolongs the display of all segments.

2.5 AUDIBLE SIGNALS

The device can generate audible signals of four types:

| Type of sound | Duration | Meaning |
|----------------------|-----------------|---|
| Low-pitched | Short | Normal use (key pressed). |
| | Permanent | Over(under-)shoot of a measurement alarm threshold (Ω , A). |
| High-pitched | Short | Abnormal use (for example, memory full). |
| | Permanent | Overshoot of a safety alarm threshold (V). |

The audible signal can be activated or deactivated in *SET-UP* (see chapter 8, menu 2). The  icon (Fig. 6, item 1) behaves as follows:

|  icon | Meaning |
|---|---|
| Visible | Buzzer activated; an alarm or a key press causes an audible signal to be emitted. |
| Missing | No audible signal is emitted. |

This programming is backed-up and retrieved at each reset. The audible alarm can be de-activated in the *SET-UP* menu (see chapter 8, menu 2).

During a measurement, a long press on the  key toggles between activation and deactivation of the buzzer.



Since the measurement frequency is audible, the operator hears a discontinuous audible signal (beep-beep). This is neither an operating fault nor an alarm, and it cannot be eliminated. This audible signal is amplified by the presence of current in the loop.

3. MEASUREMENT PRINCIPLE

The schematic diagram below illustrates the general case of measurement of the resistance of a loop comprising:

- The earth electrode R_x ;
- The earth;
- Several earth electrodes of resistance R_i ;
- A guard wire looping all of these earths, introducing an inductive component.

The clamp combines two functions in the measurement head:

- The generator winding of the clamp emits an alternating voltage having a constant level E .
- The receiver winding (current measurement) senses $I=E/Z_{loop}$.

Knowing E imposed by the generator and I measured, the value Z_{loop} can be deduced and displayed on the device. The *Advanced* mode makes it possible to distinguish the resistive and inductive parts and to refer the impedance to the network frequency.

More generally, this principle can be used to search for a defective earth. This is because the loop resistance comprises:

- R_x (the value sought);
- Z_{earth} (a value that is normally very low, less than 1Ω);
- $R_1 // R_2 // \dots // R_n$ (a negligible value: case of multiple earths in parallel);
- $Z_{guard\ wire}$ (a value that is normally very low, less than 1Ω).
- $R_{loop} = R_x + Z_{earth} + (R_1 // R_2 // \dots // R_n) + Z_{guard\ wire}$;

As an approximation, Z_{loop} can therefore be treated as equivalent to R_x .

If this value is very high, an inspection of this earth electrode is strongly recommended.

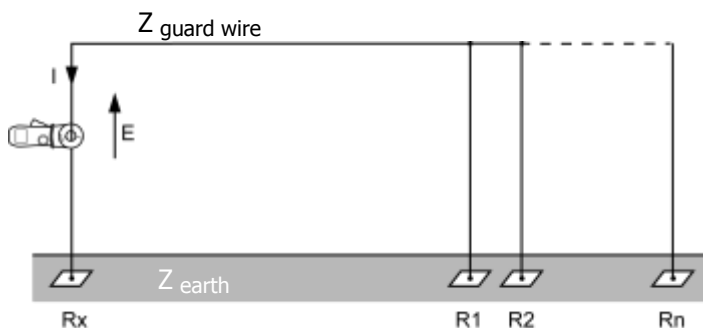

Fig. 7

4. USE

4.1 INSERTING THE BATTERIES

Refer to §11.2.

4.2 COMMISSIONING THE DEVICE

With the clamp closed and not clamping any conductor, set the function switch to a position other than **OFF**. All icons of the display unit light for approximately 2 seconds, before possible entry of the date and time (see next section).

During the first few seconds of operation, the clamp automatically adjusts correction factors serving to optimize the impedance measurement. This correction makes it possible to allow for the variations of the measurement head air gap that may occur in some particular conditions of temperature and humidity.

During this adjustment, the screen displays *CAL GAP*. If the clamp detects a problem, it indicates *Err CAL* when the switch is set to **Ω+A**. It is then necessary to check the cleanliness of the air gap, check that no conductor is encircled, and switch off and back on.

When this adjustment is done, the clamp displays the screen corresponding to the switch setting.

Note: the switching off of the device is described in chapter 9.

4.3 SETTING THE INTERNAL CLOCK

Setting the clock, which allows time-stamping of the measurements with a view to their storage, is done only the first time the device is used or after the device has been without battery power for more than 2 minutes.

Note: if time-stamping is not necessary, because for example a user has no need of time-stamped measurement records, this operation can be skipped. To skip setting the date and time, press the ► key until the measurement screen corresponding to the switch setting (Ω+A, A, MR or SET-UP) is displayed. The date and time can be set later in the SET-UP position and the Hour and Date screens; see chapter 8, menus 7 and 8.

Set the date and time. The year, month, date, display mode (AM/PM - display from 01:00 to 12:00, symbol A. or P. or 24-hour, symbol 24H), and time. Modify the blinking value with ▲ or ▼ and validate by ►. At the end of the procedure, the display unit displays the screen associated with the function selected (**Ω+A**, **A**, **MR** or **SET-UP**).

The operator must change between standard and daylight saving time manually.

4.4 STANDARD OR ADVANCED MODE

The earth clamp can be used in two ways.



- The *Standard* mode makes the standard loop ohmmeter clamp measurements.
- The *Advanced* mode is used to refine and complete the measurements:
 - Impedance referred to the selected frequency.
 - Contact voltage.
 - Resistive and inductive fractions of the loop impedance.

The choice of the *Standard* or *Advanced* mode and the alarm thresholds are parameterized in the *SET-UP* menu. See §8.5, menus 4, 5, 6, and 9 for details.

4.5 USE OF THE FUNCTIONS

| Setting of the function switch | See § |
|---------------------------------------|--------------|
| OFF | 9 |
| Ω+A | 5 |
| Use in <i>Standard</i> mode | 5.1 |
| Use in <i>Advanced</i> mode | 5.2 |
| Complementary information | 5.3 |
| Management of the alarms | 4.9 |
| A | 6 |
| MR | 7 |
| SET-UP | 8 |

4.6 USE OF THE HOLD KEY

This function, available in the **Ω+A** and **A** measurement modes, freezes the display of the measurement as soon as the **HOLD** key is pressed. The *NOISE*, clamp open () , and alarm overshoot () icons are visible if they were active.

With the *HOLD* state active:

- The **▶** key is active and can be used, in *Advanced* mode, to display the various measurement screens.
- The **MEM** key is active and can be used to record the values displayed.
- The **HOLD** key is used to exit from the *HOLD* state. The  icon goes off and the device returns to the previous function.

4.7 USE OF *PRE-HOLD*

If the *Pre-Hold* mode was activated in the configuration (see §8.5, menu 11), opening the clamp places the device in a state identical to the *HOLD* mode for as long as the clamp is open. The utility of this function is that it makes it easy to freeze the measurement with one hand, in particular when access to the **HOLD** key is difficult. If necessary, then press the **HOLD** key to freeze the device and release the handle.

If the **HOLD** key is not pressed, closing the clamp automatically causes an exit from the *Pre-hold* mode.

4.8 STORAGE OF THE DATA

The values displayed during the measurements can be stored and read out later.

4.8.1 CONDITIONS

Storage of the data is available in both the **Ω+A** and **A** measurement modes, provided that memory locations are free.

4.8.2 EFFECTIVE STORAGE

The data are stored as soon as the **MEM** key is pressed. A long audible signal confirms the storage.

4.8.3 INFORMATION CONCERNING THE STORED DATA

All calculated impedance and/or current values, together with the values accessible in the secondary screens in the *Advanced*, mode, are stored as soon as the **MEM** key is pressed, namely:

- Current measurement (A);
- Measurement of the resistance, inductance, and impedance (Z);
- Contact voltage measurement (V);
- Present configuration of the clamp;
- Sequence number of the record;
- Time and date of the record.

The display unit indicates the sequence number of the last measurement recorded, or 0 if the memory is empty. The data are preserved when the device is off or without a battery.

4.8.4 MEMORY FULL

The communicating model METRACLIP EARTH has a larger recording capacity, 2000 measurements. If the circular recording mode is activated, as soon as the threshold of 2000 values is exceeded, the sequence number is displayed alternately with *FULL* in order to report the overwriting of the oldest records. When the threshold of 9999 records is reached, the sequence number is replaced by

FULL. The next time the **MEM** key is pressed, a disablement beep is emitted and the *FULL* indication blinks.

4.8.5 READING THE STORED DATA

The data can be looked up using the **MR** function. See chapter 7.

4.9 MANAGEMENT OF THE ALARMS

The device has 3 distinct alarms that can be parameterized.



The (Ω , V, A) alarm thresholds are defined in the *SET-UP* menu, lines 4, 5, and 6; see §8.5. The alarms can be activated or deactivated in these same menus.

4.9.1 NO ALARM DETECTION

If no alarm is activated, the alarm icons are not displayed.



When no alarm is triggered, the alarm display displays the alarm threshold, along with the direction of triggering (, ) of the impedance, voltage, or current alarm.



Fig. 8

4.9.2 VOLTAGE ALARM

If the voltage (product $Z \times I$) exceeds the threshold set, the alarm symbol and the alarm threshold are displayed and blink.

If the buzzer is active, the high-pitched audible warning signal is emitted.

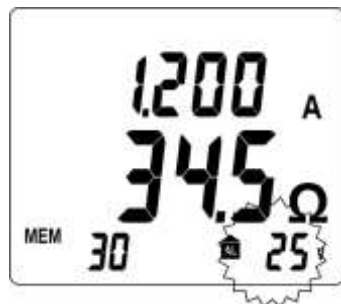

Fig. 9

4.9.3 CURRENT ALARM

If the current exceeds the threshold set, the alarm symbol and the alarm threshold are displayed and blink.

If the buzzer is active, a low-pitched audible signal is emitted.



Fig. 10

4.9.4 IMPEDANCE ALARM

If there is no voltage alarm, no detection of *NOISE*, and no current alarm, an alarm on the impedance may be triggered. If the buzzer is active, the corresponding audible signal is emitted.

4.9.4.1 Low threshold configuration

An audible signal is emitted when the impedance is below the threshold set (continuity type measurement).



Fig. 11

4.9.4.2 High threshold configuration

An audible signal is emitted at values exceeding the threshold (detection of an earthing impedance that is too high).



Fig. 12

If the impedance crosses the selected threshold, a low-pitched audible signal is emitted.

4.9.4.3 Priority of the alarms

If several alarms are triggered simultaneously, a priority rule determines the display and the corresponding sound:

- The voltage alarm has priority because it concerns the user's safety.
- The current alarm is second in priority.
- The impedance alarm is displayed when no other alarm is triggered.

5. Ω +A POSITION



Since the measurement frequency is audible, the operator hears a discontinuous audible signal (beep-beep). This is neither an operating fault nor an alarm, and it cannot be eliminated. This audible signal is amplified by the presence of current in the loop.

5.1 USE IN *STANDARD* MODE



The selection of the *Standard* mode is described in §8.5, menu 9.

5.1.1 OBJECT

In the *Standard*, mode, only one measurement screen is proposed. The clamp measures the loop impedance (Ω) at the fixed frequency of 2083 Hz and the leakage current.

5.1.2 PARAMETERIZING THE MEASUREMENT

If necessary, adjust the alarm thresholds as indicated in §8.5, menus 4, 5, and 6.

5.1.3 MEASUREMENT

- Place the conductor of the circuit to be measured in the clamp and close the clamp. If the clamp is incorrectly closed, the  icon is displayed.
- If necessary, use the **HOLD** key to freeze the measurement. See §4.6,
- If necessary, use the **MEM** key to store the measurement. See §4.8.2,

Remark:

If the measured impedance is less than 1Ω , the measurement display alternates between the value measured and the word *LOOP*, in order to call the user's attention to the risk of measuring a local loop at the test point that does not include the earthing.

5.1.4 MEASUREMENT RESULT

Once the measurement has stabilized, the display unit indicates:

- The leakage current.
- The impedance of the loop at the frequency of 2083 Hz.

The impedance is measured only if the leakage current is less than 10A. In the 10 A–40 A range, only the current is displayed; the *NOISE* symbol blinks and the impedance is replaced by dashes.



Fig. 13

5.1.5 STORAGE OF THE MEASUREMENTS

Refer to §4.8.2.

5.1.6 PRESENCE OF ALARMS

Refer to §4.8.2 If the contact voltage exceeds 50 V, the display unit indicates the current/impedance couple and the contact voltage alternately.

5.2 USE IN *ADVANCED* MODE

5.2.1 OBJECT

In this mode, 3 measurement screens are provided (impedance referred to the chosen frequency and leakage current, contact voltage, display of R and L). The clamp measures the loop impedance (Ω) at the frequency of 2083 Hz. However, in addition to what is done in the *Standard*, mode, the impedance is recalculated at the frequency defined by parameterizing.

5.2.2 SELECTION

The selection of this mode allows the display of additional measures only with switch on $\Omega+A$ position.



The selection of the *Advanced* mode is described in §8.5, menu 9.

The selection of the measurement frequency is described in §8.5, menu 10.

5.2.3 PARAMETERIZING THE MEASUREMENT

If necessary, first adjust the alarm thresholds (Ω , V, I); see §8.5, menus 4, 5, and 6.

5.2.4 MEASUREMENT

- Place the conducting wire of the circuit to be measured in the clamp and close the clamp. If the clamp is incorrectly closed, the  icon is displayed.
- If necessary, use the **HOLD** key to freeze the measurement. See §4.6.
- If necessary, use the **MEM** key to store the measurement. See §4.8.2.

5.2.5 MEASUREMENT RESULT

First screen

Once the measurement has stabilized, the display unit displays the 1st screen, which indicates:

- The leakage current.
- The loop impedance referred to the chosen frequency.

The impedance is measured only if the leakage current is less than 10 A. In the 10 A-40 A range, only the current is displayed; the *NOISE* symbol blinks and the impedance is replaced by dashes.



Fig. 14

Second screen

Press **▶** to display the 2nd screen, which indicates the contact voltage (product ZxI).

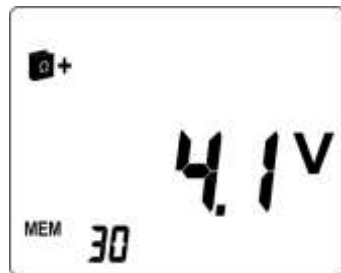

Fig. 15

Third screen

Press **▶** to display the 3rd screen, which indicates the values of R and L.

- The loop inductance and loop resistance are displayed.



Fig. 16

- When the inductive component is negligible (*) with respect to the resistive component, the symbol $R=Z$ is displayed, and only the impedance is displayed; the inductance is replaced by dashes.

(*) $R > 25 \Omega$ or $R[\Omega] / L[H] > 10^5$.



Fig. 17

5.3 COMPLEMENTARY INFORMATION

This complementary information is displayed in both the Standard and Advanced modes.

5.3.1 PRODUCT ZXI GREATER THAN 50V

In this case:

- The blinking *Noise* symbol is displayed.
- The impedance blinks.
- The hazardous voltage symbol  blinks.



Fig. 18

5.3.2 IMPEDANCE GREATER THAN 1500Ω

In this case:

- The impedance display indicates *O.R* (*Over range*).



Fig. 19

5.3.3 PERTURBING LEAKAGE CURRENT

If the current is greater than 5 A, or if it is significantly deformed:

- The blinking *Noise* symbol is displayed.
- The impedance blinks.

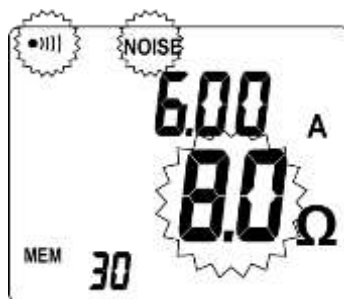

Fig. 20

5.3.4 CURRENT GREATER THAN 10A

If the current is greater than 10 A:

- The blinking *Noise* symbol is displayed.
- The impedance is replaced by - - - -

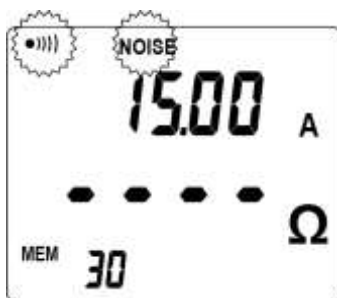

Fig. 21

If the current is greater than 40 A, the current display indicates *O.R* (*Over Range*).

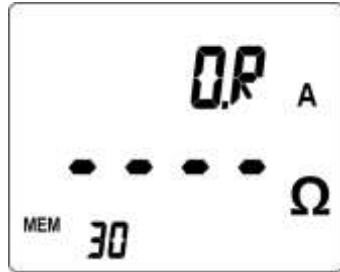

Fig. 22

5.3.5 STORAGE OF THE MEASUREMENTS

Refer to § 4.8.2.

5.3.6 PRESENCE OF ALARMS

Refer to §4.9.

6. POSITION A

6.1 OBJECT

In this mode, the clamp measures the electric current, independently of any earth measurement.

6.2 PARAMETERIZING THE MEASUREMENT

If necessary, first adjust the current alarm threshold in accordance with §8.5, menu 6.

6.3 MEASUREMENT

- Place the conducting wire of the circuit in which the current is to be measured, in the clamp and close the clamp. If the clamp is incorrectly closed, the  icon is displayed.
- If necessary, use the **HOLD** key to freeze the measurement. See §4.6.
- If necessary, use the **MEM** key to store the measurement. See §4.8.2

6.4 MEASUREMENT RESULT

Once the measurement has stabilized, the display unit indicates the value of the current in the conductor.

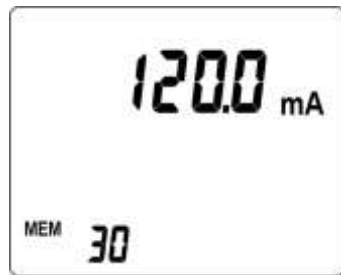

Fig. 23

6.5 PRESENCE OF ALARMS

Refer to §4.9.

6.6 MANAGEMENT OF THE ALARMS

If the preset alarm threshold is exceeded, the reminder of the threshold and the value of the current measured blink

Refer to §4.9.

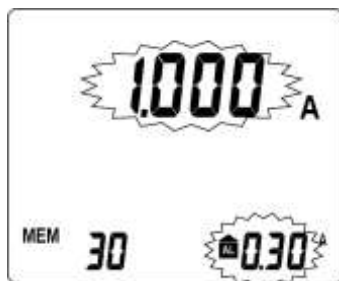

Fig. 24

7. MEMORY READ (MR)

7.1 OBJECT

The **MR** position (*Memory Read*, display of stored data) is used to display measurements previously stored by pressing the **MEM** key.

7.2 SELECTION OF THE *MEMORY READ* MODE

Set the function switch to **MR**. The choice of mode (*Standard* or *Advanced*) was made by parameterizing; see §8.5, menu 9.

7.3 DATA DISPLAYED

This depends on which mode is active, *Standard* or *Advanced*, independently of the mode in which the records were made.

7.3.1 DATA DISPLAYED IN *STANDARD* MODE

The last measurement is displayed. The *MR* memory read symbol and the sequence number of the record being read are also displayed.

The figure opposite illustrates an impedance + current measurement (**Ω +A** setting).



Fig. 25

The stored values are displayed as they were when recorded, namely, same display range, alarm states, *NOISE* signal, battery condition, etc.

However, the audible alarms are not reproduced; only the *AL* icon and the alarm threshold blink.

The figure opposite illustrates a current measurement (**A** setting).

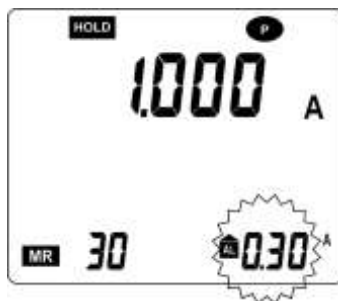

Fig. 26

Press ► to display the measurement storage date-time screen.

To exit from the memory read mode, set the rotary switch to the desired mode.



Fig. 27

7.3.2 DATA DISPLAYED IN ADVANCED MODE

The Ω + icon indicates use of the *Advanced* mode; the user then disposes of 4 distinct screens.

Screen no. 1

The last measurement is displayed, namely the impedance referred to the chosen frequency.

The *MR* memory read symbol and the sequence number of the record being read are also displayed.

The figure opposite illustrates an impedance and current measurement.

Press ► to display the next screen.



Fig. 28

Screen no. 2

The figure opposite illustrates a contact voltage measurement (product ZxI).

Press ► to display the next screen.



Fig. 29

Screen no. 3

The figure opposite illustrates a resistance and impedance measurement (switch set to $\Omega+A$). Press \blacktriangleright to display the next screen.



Fig. 30

Screen no. 4

The figure opposite illustrates the date and time of the measurement (switch set to $\Omega+A$), namely:

- 12.30: December 30.
- 15:39: 1539 hours.

Press \blacktriangleright to return to screen no. 1.

To exit from the memory read mode, set the rotary switch to the desired mode.



Fig. 31

7.3.3 USE OF THE KEYS

The \blacktriangle and \blacktriangledown keys are used to view the various stored measurements. If these keys are held down, the sequence number is scrolled at a rate of 3 **counts** per second; after 5 seconds, the rate is increased to 10 **counts** per second. Each time the sequence number changes, the value of the corresponding measurement is displayed. The MR symbol remains displayed as a reminder that the memory read function is active.

Since the reading of the buffer is circular, it is possible to scroll past the oldest recorded value to the most recent, or past the most recent recorded value to the oldest.

In the METRACLIP EARTH model, with circular recording activated, the sequence number of the oldest record is not necessarily 1: the remaining records may be numbered from 44 to 2043, for example.

7.3.4 ERASURE OF THE STORED DATA

Refer to §8.5, menu 1.

7.3.5 EXITING FROM THE READ MODE

Set the function switch to the desired measurement position (**OFF**, **Ω +A**, **A** or **SET-UP**).

8. SET-UP

8.1 OBJECT

The **SET-UP** position gives access to the following menus:

| No. | Function |
|------------|--|
| 1 | Erasure of the memory. |
| 2 | Activation/Deactivation of the buzzer. |
| 3 | Activation/Deactivation of automatic switching off. |
| 4 | Setting of the impedance alarm threshold (Ω). |
| 5 | Setting of the voltage alarm threshold (V). |
| 6 | Setting of the current alarm threshold (I). |
| 7 | Setting of the date. |
| 8 | Setting of the time. |
| 9 | Selection of the <i>Standard</i> or <i>Advanced</i> operating mode. |
| 10 | Choice of transposition frequency for the impedance. |
| 11 | Activation/Deactivation of the <i>Pre-Hold</i> mode. |
| 12 | Display of the version number. |
| - | Access to the 2 adjustment procedures (menus 13 to 14) and to the restoration procedure (menu 15). |
| 13 | Impedance measurement adjustment procedure. |
| 14 | Current measurement adjustment procedure. |
| 15 | Restoration of factory values. |

8.2 ACCESS TO THE *SET-UP* MENUS

Set the function switch to **SET-UP**.

8.3 DISPLAY OF THE *SET-UP* MENUS

Each of the 15 accessible menus is clearly identified by its title and number, as in the example opposite, voltage alarm threshold adjustment menu 5 (*AL. V*).

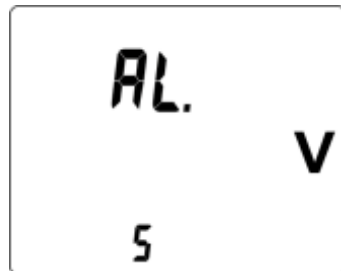

Fig. 32

8.4 SELECTING A SPECIFIC MENU

Use the keys as follows.

| Key | Action |
|------------|---|
| ▲ | Move up in the menu tree. |
| ▼ | Move down in the menu tree. |
| ▶ | Select the menu displayed or return to the previous menu. |





When changes have been made in one of the *SET-UP* menus (other than deletion), the changes can be cancelled by turning the function switch to a position other than SET-UP, provided that there has not been a return to the main menu (press on ▶).



8.5 DETAILS OF THE *SET-UP* MENUS







In order to facilitate working with these menus, the procedure for access to each menu is systematically reproduced.

| Menu no. | Indication | Object and use |
|-----------------|-------------------|---|
| 1 | CLr | Erasure of the memory <ul style="list-style-type: none">■ Enter this menu by ▶. <i>CLr</i> blinks.■ Press ▲ and ▼ simultaneously for 6 seconds. The recorded data are all erased. The meter indicates <i>MEM 0</i>.■ Return to the previous menu by ▶. |
| 2 | Snd | Activation/Deactivation of the buzzer <ul style="list-style-type: none">■ Enter the menu by ▶. <i>Snd</i> blinks.■ Press ▲ or ▼. The Buzzer is active when the ● icon is visible and deactivated when it is masked.■ Return to the previous menu by ▶. <p><i>Note:</i> in the Ω+A and A measurement modes, a long press on ▶ activates or deactivates the audible alarms.</p> |
| 3 | StOP | Activation/Deactivation of automatic switching off <ul style="list-style-type: none">■ Enter the menu by ▶. <i>StOP</i> blinks.■ Press ▲ or ▼. Automatic switching off is deactivated when the ●P icon is visible and activated when it is masked. P stands for "Permanent".■ Return to the previous menu by ▶. |

| Menu no. | Indication | Object and use |
|-----------------|-------------------|---|
| 4 | AL. Ω | <p>Setting the impedance alarm threshold (Ω)</p> <ul style="list-style-type: none"> ■ Enter the menu by ►. AL. Ω blinks. <p><i>Setting the sense of the alarm</i></p> <ul style="list-style-type: none"> ■ Press ▲ or ▼ to select the state of the alarm: <ul style="list-style-type: none"> - : deactivated. - : activated for a measurement exceeding the threshold. - : activated for a measurement below the threshold. ■ Validate by ►. <p><i>Setting the alarm value</i></p> <ul style="list-style-type: none"> ■ Press ▲ or ▼ to select the impedance alarm threshold (Fig. 6, item 12). ■ Validate by ►. The return to the previous menu is immediate. |
| 5 | AL. V | <p>Setting the voltage alarm threshold (V)</p> <ul style="list-style-type: none"> ■ Enter the menu by ►. AL. V blinks. <p><i>Activation/Deactivation of the alarm</i></p> <ul style="list-style-type: none"> ■ Press ▲ or ▼ to select the state of the alarm (Fig. 6, item 13): <ul style="list-style-type: none"> - : deactivated. - : activated for a measurement exceeding the threshold. ■ Validate by ►. <p><i>Setting the alarm value</i></p> <ul style="list-style-type: none"> ■ Press ▲ or ▼ to select the alarm threshold value (Fig. 6, item 12). ■ Validate by ►. The return to the previous menu is immediate. |

| Menu no. | Indication | Object and use |
|-----------------|-------------------|---|
| 6 | AL. A | <p>Setting the current alarm threshold (I)</p> <ul style="list-style-type: none"> ■ Enter the menu by ►. <i>AL. A</i> blinks. <p><i>Activation/Deactivation of the alarm</i></p> <ul style="list-style-type: none"> ■ Press ▲ or ▼ to select the state of the alarm (Fig. 6, item 13): <ul style="list-style-type: none"> - : deactivated. - : activated for a measurement exceeding the threshold. ■ Validate by ►. <p><i>Setting the alarm value</i></p> <ul style="list-style-type: none"> ■ Press ▲ or ▼ to select the current alarm threshold (Fig. 6, item 12). ■ Validate by ►. The return to the previous menu is immediate. |
| 7 | dAtE | <p>Setting the date</p> <ul style="list-style-type: none"> ■ Enter the menu by ►. <i>dAtE</i> blinks. ■ Press ▲ or ▼ to select the year, which blinks. Validate by ►. ■ Press ▲ or ▼ to select the month, which blinks. Validate by ►. ■ Press ▲ or ▼ to select the date, which blinks. ■ Validate by ►. The return to the previous menu is immediate. <p>Note: in some places, the order of adjustment of certain fields will be Year, Date, Month.</p> |
| 8 | HOuR | <p>Setting the time</p> <ul style="list-style-type: none"> ■ Enter the menu by ►. <i>HOuR</i> blinks. ■ Press ▲ or ▼ to select the AM/PM (A. or P.) or 24H display mode (<i>24H</i>), which blinks. Validate by ►. ■ Press ▲ or ▼ to select the hour, which blinks. Validate by ►. ■ Press ▲ or ▼ to select the minutes, which blink. ■ Validate by ►. The return to the previous menu is immediate. |

| Menu no. | Indication | Object and use |
|-----------------|-------------------|---|
| 9 | USE | <p>Selecting the <i>Standard</i> or <i>Advanced</i> operating mode</p> <ul style="list-style-type: none"> ■ Enter the menu by ►. <i>USE</i> blinks. ■ Press ▲ or ▼ to select the <i>Standard</i> or <i>Advanced</i> mode. <ul style="list-style-type: none"> - <i>Advanced</i> mode: the + icon is displayed. - <i>Standard</i> mode: <i>Std</i> is displayed. ■ Validate by ►. The return to the previous menu is immediate. |
| 10 | FrEQ | <p>Choice of transposition frequency for the impedance in <i>Advanced</i> mode</p> <ul style="list-style-type: none"> ■ Enter the menu by ►. <i>FrEQ</i> blinks. ■ Press ▲ or ▼ to select the transposition frequency of the measured impedance from among the 4 possible values: 50, 60, 128, and 2,083 Hz. ■ Validate by ►. The return to the previous menu is immediate. |
| 11 | HOLd | <p>Activation/Deactivation of the <i>Pre-Hold</i> mode</p> <ul style="list-style-type: none"> ■ Enter the menu by ►. <i>HOLd</i> blinks. ■ Press ▲ or ▼ to switch the <i>Pre-Hold</i> mode to active or inactive. <ul style="list-style-type: none"> - <i>Pre-hold</i> mode inactive: only the  icon is displayed. - <i>Pre-hold</i> mode active: the  and  icons are displayed. ■ Validate by ►. The return to the previous menu is immediate. |
| 12 | VER | <p>Display of the version number</p> <ul style="list-style-type: none"> ■ Enter the menu by ►. ■ The version number is displayed. ■ Return to the previous menu by ►. |

Adjusting the clamp

The *SET-UP* menu enables users to adjust their clamps when they judge it necessary. In order to avoid activating an adjustment procedure involuntarily, there are 2 protections:

1. In the *SET-UP* menu, the *CAL* menu is placed last. A sustained press on ► and ▲ and ▼ activates the 3 adjustment menus in *SET-UP*.
2. Once the adjustment menus have been activated, a long press (3 seconds) on ► is necessary to start each of the procedures.

| Menu no. | Indication | Object and use |
|-----------------|-------------------|---|
| - | CAL | <p>Activating the adjustment menus</p> <p>This function gives access to the following 3 sub-functions:</p> <ul style="list-style-type: none"> ■ <i>CAL R</i>: adjustment of the impedance measurement. See menu 13. ■ <i>CAL I</i>: adjustment of the current measurement. See menu 14. ■ <i>CAL dFL</i>: restoration of the factory values. See menu 15. <p>The procedure for access to these 3 sub-functions is secured; refer directly to the menus concerned for access to them.</p> |
| 13 | CAL. R | <p>Impedance measurement adjustment procedure</p> <p><i>Additional equipment necessary</i></p> <ul style="list-style-type: none"> ■ A loop of known resistance, such as the <i>Calibration loop</i>. <p><i>Adjustment of the impedance measurement</i></p> <ul style="list-style-type: none"> ■ Press ► for 3 seconds to validate <i>CAL. R</i> function 14. <p>The sensitivity of the channels used in the impedance measurement will be recalculated on a known loop (having a value between 5 and 25 Ω) and on an open loop.</p> <ul style="list-style-type: none"> ■ <i>PreS rt</i> is displayed alternately with <i>no LOOP</i>. ■ With the clamp not encircling any conductor, press ► to start the procedure. ■ After approximately 15 seconds, the display unit indicates <i>SET 25.00 Ω</i>. ■ Open the clamp and in it place a loop of known resistance, such as the optional <i>Calibration loop</i>, for example on the 7.9Ω zone. ■ Use the ▲ and ▼ keys to set the value displayed to match the known resistance. ■ Press ► to validate the value. ■ <i>run CAL</i> is displayed for approximately 10 seconds. ■ The result of the procedure is displayed: <ul style="list-style-type: none"> - <i>End CAL.R PASS</i>: valid measurement loop calibration. - <i>End CAL.R FAIL</i>: invalid measurement loop calibration. ■ Storage and return to <i>CAL R</i> menu 13 by ►. |

| | | |
|----|--------------|---|
| 14 | CAL. I | Current measurement adjustment procedure <i>Additional equipment necessary</i> <ul style="list-style-type: none"> ■ A source of stabilized 0.1 and 10 A current. <i>Adjustment of the current measurement</i> <ul style="list-style-type: none"> ■ Press ► for 3 seconds to validate <i>CAL. I</i> function 14. <p>The sensitivity of the channels used in the current measurement will be recalculated on 2 current values.</p> <ul style="list-style-type: none"> ■ <i>PreS rt</i> is displayed followed by <i>100.0 mA Set</i>. ■ Open the clamp and in it place a conductor carrying a current between 50 mA and 150 mA from the current source. ■ Use the ▲ and ▼ keys to set the value displayed to match the value of the source. ■ Press ► to validate the value. ■ The display unit indicates <i>run CAL.I</i> for approximately 15 seconds. ■ <i>PreS rt</i> is displayed followed by <i>10.00 A Set</i>. ■ Set the current source to between 9 A and 10.5 A. ■ Use the ▲ and ▼ keys to set the value displayed to match the value of the source. ■ Press ► to validate the value. ■ The display unit indicates <i>run CAL.I</i> for approximately 15 seconds. ■ The result of the procedure is displayed: <ul style="list-style-type: none"> - <i>End CAL.I PASS</i>: valid measurement loop calibration. - <i>End CAL.I FAIL</i>: invalid measurement loop calibration. ■ Storage and return to <i>CAL I</i> menu 14 by ►. |
| 15 | CAL. dFLt | Restoration of the factory values <ul style="list-style-type: none"> ■ Press ► for 3 seconds to validate <i>CAL. dFLt</i> function 15. <p>The settings of the device will all be returned to the factory values. However, the stored configuration and measurements are not erased.</p> <ul style="list-style-type: none"> ■ <i>PreS rt</i> is displayed. Press ►. ■ <i>End dFLt PASS is displayed</i>: ■ Storage and return to <i>CAL dFLt</i> menu 15 by ►. |

Note: if an adjustment operation fails (*FAIL* message), check that there is nothing interfering with the closing of the clamp, then repeat the operation. If the problem persists, the clamp must be sent back for repair (see 11.5 **Fehler! Verweisquelle konnte nicht gefunden werden.**).

9. OFF POSITION

The device can be switched off manually or automatically.

9.1 MANUAL SWITCHING OFF

Set the function switch to **OFF**.

9.2 AUTOMATIC SWITCHING OFF

The automatic switching off function acts after 5 minutes of inactivity, meaning no key pressed, no change of switch setting, and no opening of the clamp.

Fifteen seconds before this stop, a short audible signal is emitted and the display unit blinks once a second.

Automatic switching off can be deactivated in the set-up menu; see §8.5, menu 3. The *P* symbol is then displayed. This function is stored.

9.3 BACKUP OF THE CONFIGURATION

The date and time are kept up to date when the device is off. If the batteries are replaced or withdrawn with the clamp in the **OFF** position, the date and time are saved for at least 2 minutes. Beyond that, the date and time may be lost and have to be reset. The following data are saved when the device is off or after withdrawal of the batteries:

- Stored measurements.
- Activation/deactivation of the buzzer.
- Activation/deactivation of automatic switching off.
- Values of the thresholds and senses of the alarms.
- Choice of the *Standard* or *Advanced* mode.
- Impedance transposition frequency in *Advanced* mode.
- Activation/deactivation of the *Pre-hold* mode.

9.4 PROLONGED STOP

Withdraw the batteries from the device if a long period of non-use is anticipated.

10. TECHNICAL CHARACTERISTICS

10.1 REFERENCE CONDITIONS

| <i>Quantities of influence</i> | <i>Reference conditions</i> |
|---|---|
| Ambient temperature | 23±3 °C. |
| Relative humidity | 50%RH±10%. |
| Battery voltage | 6 V±0.2 V. |
| Magnetic field | < 40 A/m DC. No AC field. |
| Electric field | < 1 V/m. |
| Operating position | Clamp horizontal. |
| Position of the conductor in the clamp | Centred. |
| Measurement environment | No adjacent conductors carrying current within 10 cm. |
| Proximity to magnetic mass | > 10 cm. |
| Loop resistance | Non-inductive resistance (20 Ω for the voltage measurement). |
| Measured current, sinusoidal frequency | Frequency 50 Hz. Level of distortion < 0.5%. |
| Spurious current in loop resistance measurement | Zero for the resistance and inductance measurements. < 3.75 A for the voltage measurement. |

10.2 ELECTRICAL CHARACTERISTICS

10.2.1 LOOP RESISTANCE MEASUREMENT

Measurement range:

- Loop ohmmeter function: 0.01 Ω to 1500 Ω. 1500-counts display.

| <i>Measurement ranges (Ω)</i> | <i>Resolution (Ω)</i> | <i>Intrinsic uncertainty</i> |
|-------------------------------|-----------------------|------------------------------|
| 0.010 to 0.099 | 0.001 | ±1.5% ±0.01 Ω |
| 0.10 to 0.99 | 0.01 | ±1.5% ±2R |
| 1.0 to 49.9 | 0.1 | ±1.5% ±R |
| 50.0 to 99.5 | 0.5 | ±2% ±R |
| 100 to 199 | 1 | ±3% ±R |
| 200 to 395 | 5 | ±5% ±R |
| 400 to 590 | 10 | ±10% ±R |
| 600 to 1,150 | 50 | About 20% |
| 1,200 to 1,500 | 50 | About 25% |

Alarm: range of threshold from 1 Ω to 199 Ω. R=resolution

Measurement frequency: 2083 Hz.

Transposition frequency: choice of 50, 60, 128, or 2083 Hz for the impedance calculation.

Maximum overloads: - permanent current 100 A maximum (50/60 Hz).
- transient current (< 5 s) 200 A (50/60 Hz).

10.2.2 LOOP INDUCTANCE MEASUREMENT

| Measurement ranges (μH) | Resolution (μH) | Intrinsic uncertainty |
|--|--|------------------------------|
| 10 to 100 | 1 | $\pm 5\% \pm R$ |
| 100 to 500 | 1 | $\pm 3\% \pm R$ |

10.2.3 ESTIMATE OF THE CONTACT VOLTAGE

Measurement range:

- Contact voltage function: value calculated as the product of the loop impedance by the leakage current.

| Measurement ranges (V) | Resolution (V) | Intrinsic uncertainty |
|-------------------------------|-----------------------|------------------------------|
| 0.1 to 4.9 | 0.1 | $\pm 5\% \pm R$ |
| 5.0 to 49.5 | 0.5 | $\pm 5\% \pm R$ |
| 50.0 to 75.0 | 1 | $\pm 10\% \pm R$ |

Alarm: range of thresholds from 1V to 75V.

10.2.4 CURRENT MEASUREMENT

Measurement range:

- Ammeter function: 0.2 to 40A. 4000-counts display.

| Measurement ranges (A) | Resolution (A) | Intrinsic uncertainty |
|-------------------------------|-----------------------|------------------------------|
| 0.200 to 0.999 mA | 1 μA | $\pm 2\% \pm 50 \mu\text{A}$ |
| 1.000 to 2.990 mA | 10 μA | $\pm 2\% \pm 50 \mu\text{A}$ |
| 3.00 to 9.99 mA | | |
| 10.00 to 29.90 mA | 100 μA | $\pm 2\% \pm R$ |
| 30.0 to 99.9 mA | | |
| 100.0 to 299.0 mA | 1 mA | $\pm 2\% \pm R$ |
| 0.300 to 0.990 A | | |
| 1,000 to 2,990 A | 10 mA | $\pm 2\% \pm R$ |
| 3.00 to 39.99 A | | |

Alarm: range of thresholds from 1 mA to 40 A.

10.3 VARIATIONS IN THE DOMAIN OF USE

The influence is characterized by an *Accuracy class* number for each quantity of influence.

| Quantity of influence | Limit of the Domain | Quantities influenced | Influence | |
|--------------------------------|---------------------------------------|------------------------|--------------------|----------------------|
| | | | Typical | Max |
| Temperature | -20 °C to +55° C | A, $\Omega^{(1)}$, Uc | 1 ct/10°C +R | 2 ct/10°C +R |
| Relative humidity | 10% RH to 90% RH | A, $\Omega^{(1)}$, Uc | 1 ct+R | 3 ct+R |
| Battery voltage | 4 to 6.5V | A, $\Omega^{(1)}$, Uc | 0.1 ct+R | 0.25 ct+R |
| Position of conductor | of from the edge to the centre | A, Uc | 0.1 ct+R | 0.2 ct+R |
| Position of clamp | +/-90°, 180° | $\Omega^{(1)}$ | 0.05 ct+R | 0.1 ct+R |
| | | A | 0.2 ct+R | 0.4 ct+R |
| Proximity to magnetic mass | Steel sheet 1mm thick against air gap | Uc, $\Omega^{(1)}$ | 0.1 ct+R | 0.25 ct+R |
| | | A, $\Omega^{(1)}$, Uc | 0.1 ct+R | 0.5 ct+R |
| Magnetic field at 50...60 Hz | 30A/m | A | 2mA ⁽²⁾ | 4.5mA ⁽²⁾ |
| | | Uc | 0.1 ct+R | 0,5 ct+R |
| Frequency of the current | 47 to 800 Hz | A, Uc | 1 ct+R | 2 ct+R |
| Leakage current at 50....60 Hz | I<10 A Rxl<50 V | $\Omega^{(1)}$ | 2 ct+R | 8 ct+R |

⁽¹⁾: Ω designates the quantities R, L, and Z.

⁽²⁾: Offset on the current measurement.

10.4 POWER SUPPLY

- 4 1.5 V LR6 (AA) alkaline batteries or 4 Ni-MH batteries.
- Mean consumption: approximately 140 mA.
- Mean life: approximately 12 hours, or 1,440 30-second measurements.

Remark: extreme environmental conditions may perturb the internal microprocessor. Simply disconnecting the battery may be enough to eliminate this malfunction.

The batteries will be withdrawn for long-term storage.

10.5 ENVIRONMENTAL CONDITIONS

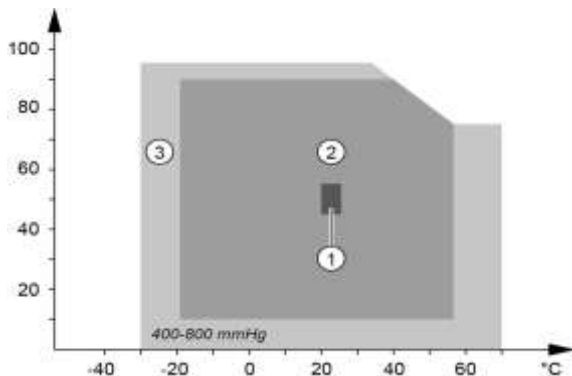

Fig. 33

1. Domain of reference (CEI160).
2. Domain of operation.
3. Domain of storage (without batteries). According to CEI359 category II (equipment for indoor and outdoor use).

10.6 MECHANICAL CHARACTERISTICS

Dimensions: 55x95x262 mm (thickness, width, height).

Max. clamping diameter: 35 mm.

Opening: 35 mm.

Weight: approximately 935 g with batteries.

Display unit: 152-segment OLED. Active surface area 48x39 mm.

Tightness: IP40, group III equipment.

Drop test: according to IEC-61010-1.

10.7 COMPLIANCE WITH INTERNATIONAL STANDARDS

Device fully protected by double insulation .

EN61010-1

EN61010-2-030

EN61010-2-032

10.8 ELECTROMAGNETIC COMPATIBILITY

The device is compliant with standard IEC-61326-1.

11. SERVICING AND MAINTENANCE



Except for the batteries, the instrument contains no parts likely to be replaced by personnel who are not specially trained and accredited. Any unauthorized repair or replacement of a part by an “equivalent” may gravely impair safety.

11.1 CLEANING

Disconnect everything connected to the device and set the switch to **OFF**.

Use a soft cloth, dampened with soapy water. Rinse with a damp cloth and dry rapidly with a dry cloth or forced air. Do not use alcohol, solvents, or hydrocarbons.

Keep the air gap of the clamp perfectly clean.

11.2 REPLACEMENT OF THE BATTERIES

If the low battery symbol on the screen blinks (*Fig. 6*, item 8), the batteries must be replaced promptly. Display of the Lo bat message indicates that the batteries must be replaced for it to be possible once again to use all functions of the clamp.

11.2.1 PROCEDURE

- Disconnect everything connected to the device and set the switch to **OFF**.
- Use a cross-headed or plain screwdriver to unscrew the 2 attachment screws (*Fig. 5*, item 10) and remove the battery compartment cover (*Fig. 5*, item 11).
- Withdraw the old batteries and replace them with 4 new batteries having identical characteristics (LR6, AA, 1.5 V); take care with the polarities.
Note: the alkaline batteries can be replaced by Ni-MH rechargeable batteries (AA, 1.2 V) having similar characteristics. However, the time between the low battery message and the automatic switching off of the device will be shorter with the rechargeable batteries.



Spent batteries must not be treated as ordinary household waste. Take them to the appropriate recycling collection point.

- Close the battery compartment cover and screw the two screws back in.
- Check the proper operation of the device.

11.2.2 PRESERVATION OF STORED DATA

When the batteries are removed, the data (recorded measurement values, alarm thresholds) are preserved. The date and time must be reset if the batteries are out for more than 2 minutes.

11.3 CHECK OF ACCURACY

11.3.1 OBJECT AND EQUIPMENT NECESSARY

Regular checking serves to verify the accuracy of the clamp and thereby detect any need for an adjustment.

11.3.2 EQUIPMENT

Standard loop resistance available as an accessory. Simulates 5 loop resistance values.

11.3.3 PROCEDURE

Place the calibration loop in the jaws of the clamp. Set the function switch of the device to **Ω+A**, then compare the measurement displayed with the value marked on the segment placed in the clamp. Repeat this process for each standard value of the calibration loop.

Depending on the measurement errors found, you may decide that your clamp must be calibrated. The first step is to carry out the adjustment procedure described in §11.4, before getting in touch with your supplier.

- Standard loop values: 7.9 Ω / 12.4 Ω / 22 Ω / 49.5 Ω / 198 Ω.
- Accuracy of these values 0.3% typical, 0.5% max.
Remark: the accuracy of the device must be added to the accuracy of the standard values.

11.4 ADJUSTMENT

11.4.1 OBJECT AND EQUIPMENT NECESSARY

Regular adjustment is required; the more intensively the device is used, the more often it will have to be adjusted.

The user can perform 2 adjustment operations in addition to restoring the factory settings, directly on the clamp, in the SET-UP position.

11.4.2 EQUIPMENT

Standard loop resistance available as an accessory. Simulates 5 loop resistance values.

11.4.3 PROCEDURE

Refer to §8.5, menu no. 13, 14, 15.

11.5 METROLOGICAL CHECK, REPAIR AND REPLACEMENT PARTS SERVICE, CALIBRATION CENTER



Like all measuring or testing devices, regular instrument verification is necessary.

If required, please contact:

GMC-I Service GmbH
Service-Center
Thomas-Mann-Strasse 20
90471 Nürnberg • Germany
Phone +49 911 817718-0
Fax +49 911 817718-253
E-Mail **service@gossenmetrawatt.com**
www.gmci-service.com

This address is only valid in Germany.

Please contact our representatives or subsidiaries for service in other countries.

11.6 PRODUCT SUPPORT

If required, please contact:

GMC-I Messtechnik GmbH
Product Support Hotline
Phone +49 911 8602-0
Fax +49 911 8602-709
E-Mail **support@gossenmetrawatt.com**

12. WARRANTY

Except as otherwise stated, our warranty is valid for **twelve months** starting from the date on which the equipment was sold. Extract from our General Conditions of Sale, provided on request.

The warranty does not apply in the following cases:

- Inappropriate use of the equipment or use with incompatible equipment.
- Modifications made to the equipment without the explicit permission of the manufacturer's technical staff.
- Work done on the device by a person not approved by the manufacturer.
- Adaptation to a particular application not anticipated in the definition of the equipment or not indicated in the user's manual.
- Damage caused by shocks, falls, or floods.

13. TO ORDER

EARTH CLAMP METRACLIP EARTH..... M312N

Supplied in a carrying case with:

- 4 LR6 or AA alkaline batteries
- a test report
- a CD ROM containing the user manuals (one per language)
- a multilingual quick start guide
- a multilingual safety data sheet
- a Calibration loop

06 - 2015
Code 694302B02 - Ed. 3

Subject to change without notice • A pdf version is available on the Internet

 **GOSSEN METRAWATT**

GMC-I Messtechnik GmbH

Südwestpark 15

90449 Nürnberg • Germany

Phone+49 911 8602-111

Fax +49 911 8602-777

E-Mail info@gossenmetrawatt.com

www.gossenmetrawatt.com